

鳥取県環境学術研究等振興事業費補助金研究実績報告書

研究期間（2年目/3年間）

研究者 又は 研究代表者	氏名	(ふりがな) リ さんそく 李 相錫
	所属研究機関 部局・職	鳥取大学大学院工学研究科・教授 電話番号 0857-31-5961 電子メール sslee@ele.tottori-u.ac.jp
研究課題名	湖沼の水質モニタリング用MEMSセンサとユビキタスセンサネットワークシステムの開発	
研究結果	<ul style="list-style-type: none"> <li>・ pH値が4、7、10である標準試薬を用いてpHセンサの評価を行った。その結果、それぞれのpH値に対する電圧が測定され、pHセンサの動作を確認できた。さらに連続的な標準試薬の投入に対しても測定電圧値が連動して変化し、pH値の変動においても対応可能であることが確認できた。</li> <li>・ 樹脂を用いた新しいマイクロ流体デバイスの作製法を提案した。</li> <li>・ 簡便な光学的な手法を用いて濁度とクロロフィルを検出する方法を提案し、検証実験のため必要な実験系を確立した。</li> <li>・ 水の温度差を用いた発電デバイスの実現可能性について検討した。</li> <li>・ センサネットワーク用モジュール（ノードの筐体）を提案、設計、試作を行った。</li> <li>・ 水中微生物（シュワネラ菌などの電流発生菌）のBODセンサへの応用可能性を検討した。</li> </ul>	
研究成果	<ul style="list-style-type: none"> <li>・ pHセンサにおいて各々の標準試薬と連続的な標準試薬の投入に対して動作が確認でき、湖沼の水質モニタリング用センサの一つとして応用可能性が検証できた。</li> <li>・ 新しいマイクロ流体デバイスの作製技術が確立できた。</li> <li>・ 濁度とクロロフィルセンサとして提案した簡便な光学的な手法が有効であることがわかった。</li> <li>・ 設計、試作したセンサネットワークノードの筐体を水槽（プール）で検証実験を行った結果、浸水もなく問題ないことが確認でき、より実用化に近づいた。</li> </ul>	
次年度研究計画	<ul style="list-style-type: none"> <li>・ pHセンサの作製に樹脂を用いた新しいマイクロ流体デバイスの作製法を応用し、pHセンサの動作を確認する。</li> <li>・ クロロフィルセンサの原理検証実験を行う。また濁度やクロロフィルセンサとpHセンサとが集積化されたマイクロ流体デバイスを提案する。そのため、マイクロレンズを試作し、その性能を確認する。</li> <li>・ センサネットワークノードの筐体を複数試作し、市販のセンサを用いて無線センサネットワークの検証実験を行う。</li> <li>・ 水の温度差を用いた発電デバイスと、新しいBODセンサの原理検証実験を行う。</li> </ul>	
報告責任者	所属・職 氏名	研究・国際協力部研究協力課・課員・朝野弘昭 0857-31-5494 ken-jyosei@adm.tottori-u.ac.jp

注1) 表題には、環境部門、地域部門、北東アジア学術交流部門のいずれかを記載すること。

2) 「研究期間（ 年目/ 年間）」及び「次年度研究計画」は、環境部門のみ記載すること。

3) 研究者の知的財産権などに関する内容等で、非公開としたい部分は、罫線で囲うなど明確にし、その理由を記すこと。

4) 研究実績のサマリーを併せて提出すること。

# Turbidity Monitoring of Lake Water by Transmittance Measurement with a Simple Optical Setup

Ryohei Komiyama, Tomoaki Kageyama, Masashi Miura, Hidetoshi Miyashita and Sang-Seok Lee  
Graduate School of Engineering  
Tottori University  
Tottori, Japan  
sslee@ele.tottori-u.ac.jp

**Abstract**—We are developing a wireless sensor network system for the lake water quality monitoring, which consists of sensor module, wireless transceiver module, control IC's and power module. In the sensor module, sensors to monitor the water quality such as pH sensor, turbidity sensor, chlorophyll concentration sensor and dissolved oxygen concentration sensor, will be integrated as a microfluidic device. The power module of a sensor node of the wireless sensor network system will be implemented with solar cells and thermoelectric effect based energy harvesting devices utilizing temperature difference between the surface and the bottom water layer. In this paper, we report the feasibility study results of a turbidity sensor that will be integrated into the sensor module for the lake water quality monitoring. Our turbidity sensor has been achieved by a simple optical setup, which consists of LED and photodiode. The turbidity is determined by measuring the transmittance of scattered LED light by the particles in the water sample. As a result of experiments with the lake water sample, we could verify that our simple optical measurement setup can be a useful tool in turbidity sensing.

**Keywords**—water quality monitoring; turbidity; optical setup

## I. INTRODUCTION

In these days, environmental monitoring system is an important research and development topic in terms of the preservation of environmental systems [1-6]. The targets of the environment monitoring system are very wide. For instance, it will be air pollution, soil pollution, water pollution, noise pollution, radiation pollution and so on. Especially, we focus on water pollution monitoring in this paper, which is one of important issues in worldwide because the water quality monitoring is closely related to the quality of drinking water, and water for fishery and agriculture. In typical water quality monitoring systems, physical and chemical quantities, such as pH, turbidity, dissolved oxygen concentration, chlorophyll concentration, temperature and so on, have been monitored.

However, a commercially available conventional water quality monitoring system has generally high cost and large size. The high cost of the monitoring systems prevents real time and continuous monitoring of a large area. In other words, the sufficient numbers of water quality monitoring system are not able to be established in the large natural resources like the

lake due to the high cost of monitoring system. It also causes low monitoring accuracy.

In order to obtain a low cost water quality monitoring system, we have proposed a wireless sensor network system for the high accuracy water quality monitoring. Our wireless sensor network system consists of sensor module, wireless transceiver module, control IC's for sensors, communication and power management, and power module. In the sensor module, various sensors to monitor water quality such as pH sensor, turbidity sensor, chlorophyll concentration sensor and dissolved oxygen concentration sensor will be integrated as a microfluidic device. Among those sensors, we have developed a pH sensor. Our pH sensor measures pH with three electrodes which are working, counter and reference electrode. We have integrated three electrodes into the microfluidic channel even including reference electrode. It can be applicable to not only water quality monitoring but also other fields like nanoparticle synthesis monitoring [7]. Moreover, we are developing a turbidity sensor, which measures the turbidity by measuring the transmittance of scattered light by the particles in the water sample. In this paper, we report the feasibility study results of the turbidity sensor implemented with a simple optical setup.

## II. EXPERIMENT

### A. Optical Setup for Turbidity Sensing

In order to detect turbidity rapidly and accurately, we adopted optical detection method. A schematic view of our optical measurement setup for the turbidity detection is shown in Fig. 1. The optical measurement setup consists of LED light source, photodiode and socket. The turbidity is obtained by measuring photovoltage of photodiode, which is correlated to the transmittance of scattered LED light by particles in water sample. In other words, the higher turbidity is, the larger photovoltage is due to higher scattering by many small particles. The experiment is performed in the dark box to prevent the effect of environmental light exposure. The measurement optical setup shown in Fig. 1 is for verification of the turbidity sensing principle, and the LED light source and photodiode will be integrated into the microfluidic device based pH sensor. Furthermore, in near future, we are going to implement them by thin film layers, which give more compact sized sensor module for water quality monitoring. In Fig. 2,

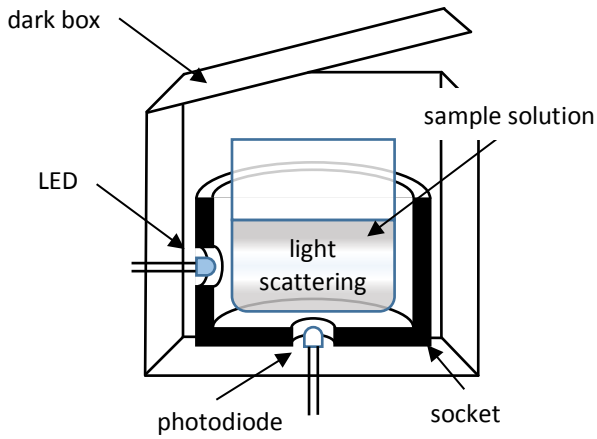

Fig. 1. Schematic view of our optical measurement setup.

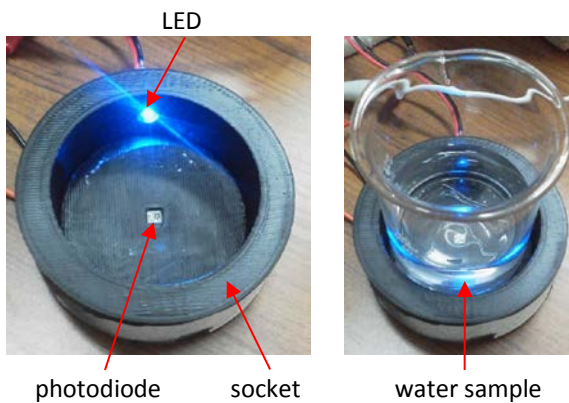

Fig. 2. Photograph of our optical measurement setup.

the photographs of optical measurement setup are shown. In the measurement setup, a blue LED (OSUB5111A-ST, OptoSupply) is used for the light source, whose central wavelength is 470 nm. The photodiode (S7183, Hamamatsu Photonics) for the scattered light detection has sensitivity range from 300 to 1000 nm. The socket to fix the light source, photodiode and water sample is fabricated by 3D printing technique. When we measured the turbidity with the measurement setup shown in Fig. 2, it was put into the dark box likely shown in Fig. 1. The equivalent circuit diagram of the measurement setup is shown in Fig. 3. The power supply voltage ( $V_{cc}$ ), current control resistor ( $R1$ ) for LED, and bias resistor ( $R2$ ) for photovoltage measurement are 5 V, 0.984 k $\Omega$ , and 9.89 k $\Omega$ , respectively.

### B. Turbidity Measurements

In order to confirm the feasibility of our optical measurement setup before performing integration of turbidity sensor into microfluidic based pH sensor, we have performed experiments with the lake water samples.

Before the measurement, first of all, we have calibrated the turbidity sensor with standard solutions to clarify the correlation between the turbidity and the photovoltage.

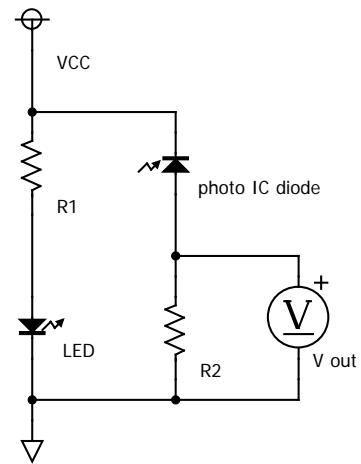

Fig. 3. The equivalent circuit diagram of our experiment setup.

In international standard ISO 7027 for measuring turbidity by the scattered light method, formazine solution is recommended for the turbidity standard solution. However the formazine is difficult to handle because the formazine hydrazine sulfate is necessary during synthesis process that is carcinogenic agent.

On the other hand, kaolin is prevalently utilized as a turbidity standard solution for a long time. Since kaolin is clay mineral, it is completely free of anything harmful, easy to handle and low cost material. However, kaolin solution is easy to settle down. It causes a problem that the turbidity is varied during the measurement. In order to resolve the problem, the styrene microbeads are proposed as the turbidity standard solution. However, the styrene microbeads turbidity standard solution is much expensive than other turbidity standard solutions.

In the calibration, firstly we utilized 100 NTU (Nephelometric Turbidity Unit) styrene microbeads standard solution as the reference. Furthermore, in order to obtain accurate calibration curve, we also calibrated with 100 NTU kaolin standard solution and the calibration result was compared with that by the 100 NTU styrene microbeads standard solution. After the confirmation of calibration results with 100 NTU two different standard solutions, we established calibration curve with kaolin standard solutions having various NTU values. The calibration result is shown in Fig. 4. We measured photovoltages 4 times for each kaolin standard solution and the mean values are shown in Fig. 4. We were able to confirm the high linearity in case of under the 80 NTU, which is sufficient to measure the turbidity for usual lake water.

Next, we performed the measurement with the water of the Lake Koyama. The Lake Koyama is a brackish lake and located nearby our university campus at Tottori prefecture in Japan. The Lake Koyama has an area of about 7 km<sup>2</sup> and its maximum water depth is 6.5 m. The location of the Lake Koyama and sampling places in it are indicated in Fig. 5. We measured the turbidity of 9 places. Among them, the sampling places No. 2 and No. 3 are near the inlets and the place No. 8 is near the outlet for the lake water.

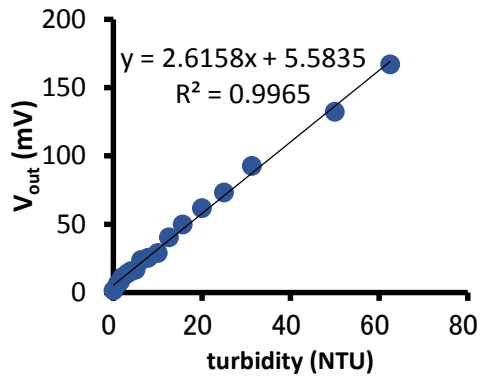

Fig. 4. The calibration curve of our turbidity sensor for kaolin standard solutions

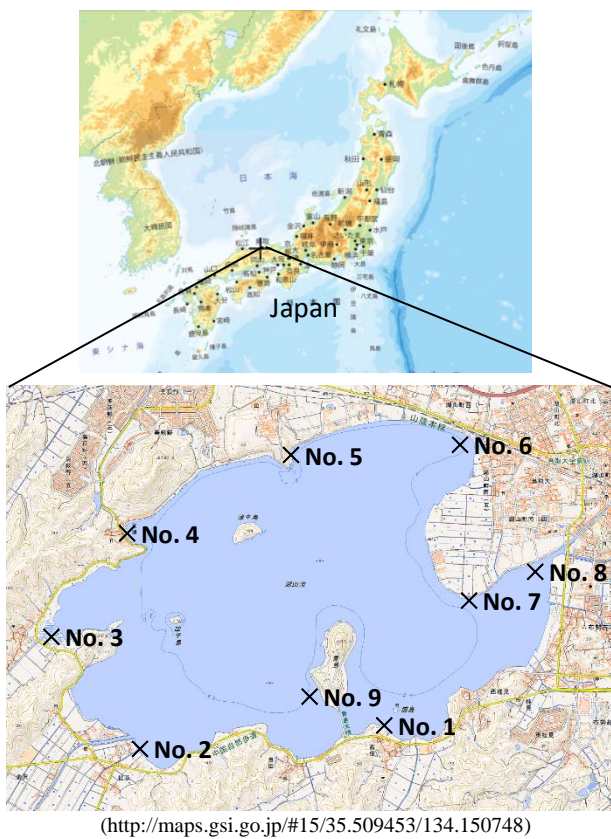

Fig. 5. Sampling points of the Lake Koyama.

Fig. 6 shows the photographs of the sampling places of No. 1 to No. 3 and water samples at those places. The water samples were obtained from the lakesides at each sampling point on January 2015. At each sampling point, the lake water was clear when inspected by the naked eyes. Moreover, we could not distinguish the turbidity of each water sample by the naked eyes.

The water samples were set into the socket in the laboratory as shown in Fig. 1 and Fig. 2. In the turbidity measurement, we

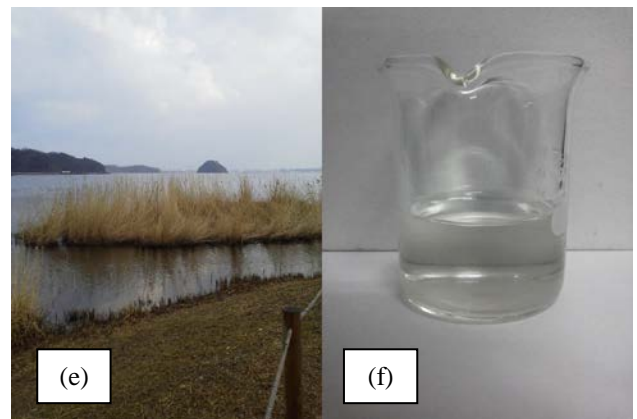
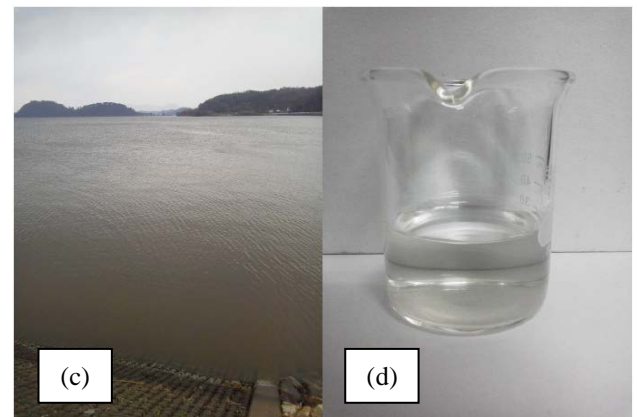
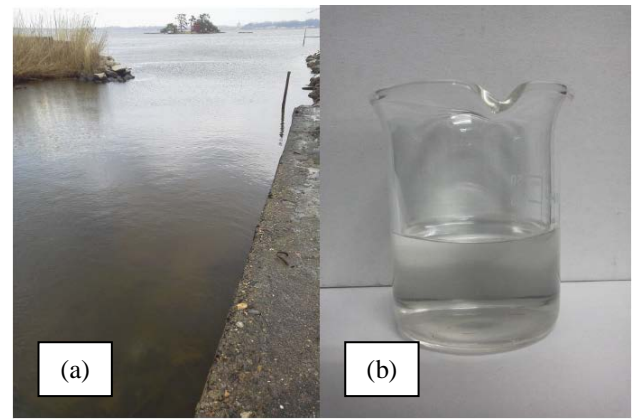

Fig. 6. The photographs of (a), (c) and (e) show the sampling places in the Lake Koyama of No.1, No. 2 and No. 3 in Fig. 5, respectively. Moreover, the photographs of (b), (d) and (f) show the water samples obtained at the places of No. 1, No. 2 and No. 3 in Fig. 5, respectively.

measured 10 samples in total, which are 9 water samples obtained from the Lake Koyama and 1 purified water sample for comparison. The turbidity measurement results are summarized in Fig. 7, which calibrated by the results shown in Fig. 4.

By the turbidity measurement with our simple optical setup, we were able to distinguish clearly the turbidity of the water samples although they were seen similarly by the naked eyes.

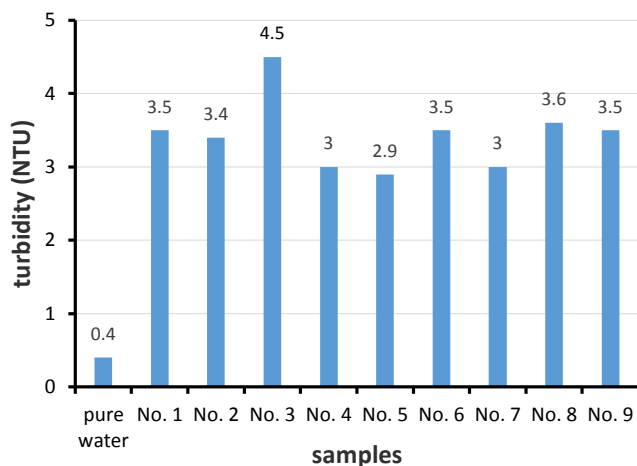

Fig. 7. The turbidity measurement results of the lake water samples obtained from the Lake Koyama. The sample numbers are corresponding to those in Fig. 5.

In Fig. 7, the turbidity of the sample No. 3 is 4.5 NTU, which is the largest value. It seems that the inflow of clay due to some works near the sampling place No. 3 around the sampling date is caused to increase of the turbidity.

### III. CONCLUSIONS AND FUTURE WORKS

We have proposed the turbidity sensor implemented with a simple optical measurement setup for the lake water quality monitoring. The turbidity sensor has been developed as a sensor of the sensor module for wireless sensor network environmental monitoring system. We have also developed the microfluidic device based pH sensor, which is also a component of the sensor module. Before the integrating the turbidity sensor with the pH sensor, we have performed feasibility study with the lake water samples. In the measurement, the lake water samples were utilized and we could successfully achieve the quantification of the turbidity although we could not distinguish the turbidity of the lake water samples with only naked eyes. As a result, we could confirm the feasibility of our turbidity sensor implemented

with a simple optical measurement setup.

In near future, our turbidity sensor will be integrated with the microfluidic device based pH sensor. Moreover, we are going to develop other sensors for water quality monitoring such as chlorophyll concentration sensor and dissolved oxygen concentration sensor. Besides the sensors, the power generation devices and the control circuits will be also developed and integrated to realize the wireless sensor network system for the water quality monitoring.

### ACKNOWLEDGMENT

This work was supported by Tottori prefecture research fund for the promotion of environmental academic research.

### REFERENCES

- [1] E. T. Harvey, S. Kratzer, and P. Philipson, "Satellite-based water quality monitoring for improved spatial and temporal retrieval of chlorophyll-a in coastal waters," *Rem. Sens. Env.*, vol. 158, pp. 417-430, 2015.
- [2] I. Kiefer, D. Odermatt, O. Anneville, A. Wuest, and D. Bouffard, "Application of remote sensing for the optimization of in-situ sampling for monitoring of phytoplankton abundance in a large lake," *Sci. Tot. Env.*, vol. 527, pp. 493-506, 2015.
- [3] D. Bhattacharjee and R. Bera, "Development of smart detachable wireless sensing system for environmental monitoring," *Internat. J. Smart Sens. Intelli. Syst.*, vol. 7, pp. 1239-1253, 2014.
- [4] Q. Wei, R. Nagi, K. Sadeghi, S. Feng, E. Yan, S. J. Ki, R. Caire, D. Tseng, and A. Ozcan, "Detection and spatial mapping of mercury contamination in water samples using a smart-phone," *ACS Nano*, vol. 8, pp. 1121-1129, 2014.
- [5] M. Czugala, C. Fay, N. E. O'Connor, B. Corcoran, F. B.-Lopez, and D. Diamond, "Portable integrated microfluidic analytical platform", *Talanta* vol. 116, pp.997-1004, 2013.
- [6] K. S. Yu, J. Gil, J. Kim, H. J. Kim, K. Kim, D. Park, M. Kim, H. Shin, K. Lee, J. Kwak, and E. Yoon, "A miniaturized low-power wireless remote environmental monitoring system based on electrochemical analysis," *Sens. Act. B*, vol. 102, pp. 27-34, 2014.
- [7] R. Komiyama, H. Miyashita, H. Okura, T. Kageyama, T. Ishigaki, K. Ohmi, and S.-S. Lee, "A microfluidic device fully integrated with three pH sensing electrodes and passive mixer for nanoparticle synthesis," *Proc. of IEEE Sensor 2015*, 2015 (to be appeared).